



Prestige: Pedicure chair for beauty centre

Optimise time and space with this "all in one" beauty chair! Designed specifically for manicure and pedicure treatments, with the PRESTIGE you have everything you need in one product; compact, functional and a compelling design. A pull-out drawer - perfectly camouflaged by upholstered padding - conceals a stainless-steel pedicure basin. The padded armrests are equipped with two hand supports specifically for manicure treatments. However, that's not all; the Prestige is also extremely comfortable! With a reclining backrest and height-adjustable leg rest, your customers can indulge in a moment of extreme relaxation during treatment. The Prestige is available in a choice of Skai Colours, either one or two-tone, at no extra cost.

ARTICOLI

MB/PC160

MATERIALS

Seat, back and armrests in wood, padded with extra thick foam and covered in skai.
Integrated manicure shelves.
Stainless steel basin for pedicure treatments.

IN PHOTO: MB/PC160 - COLOUR A: VINTAGE WHITE G3 / B: VINTAGE BLUE K2

Le immagini sono fornite al solo scopo illustrativo e non costituiscono elemento contrattuale

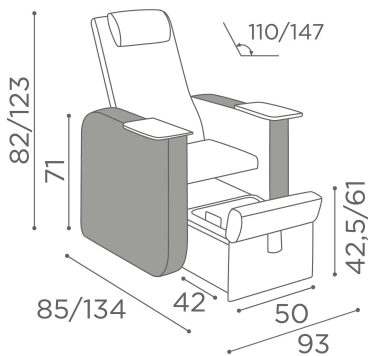

Colours: A B



All Medical&Beauty products are available in a wide choice of colours at no extra cost!



All Medical&Beauty products are available in a wide choice of colours at no extra cost!



champagne 10



black coffee 59

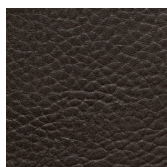

hot chocolate 60



milk 61



tea 62

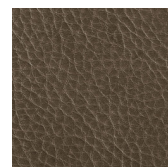

cappuccino 63



espresso 64



light grey G5

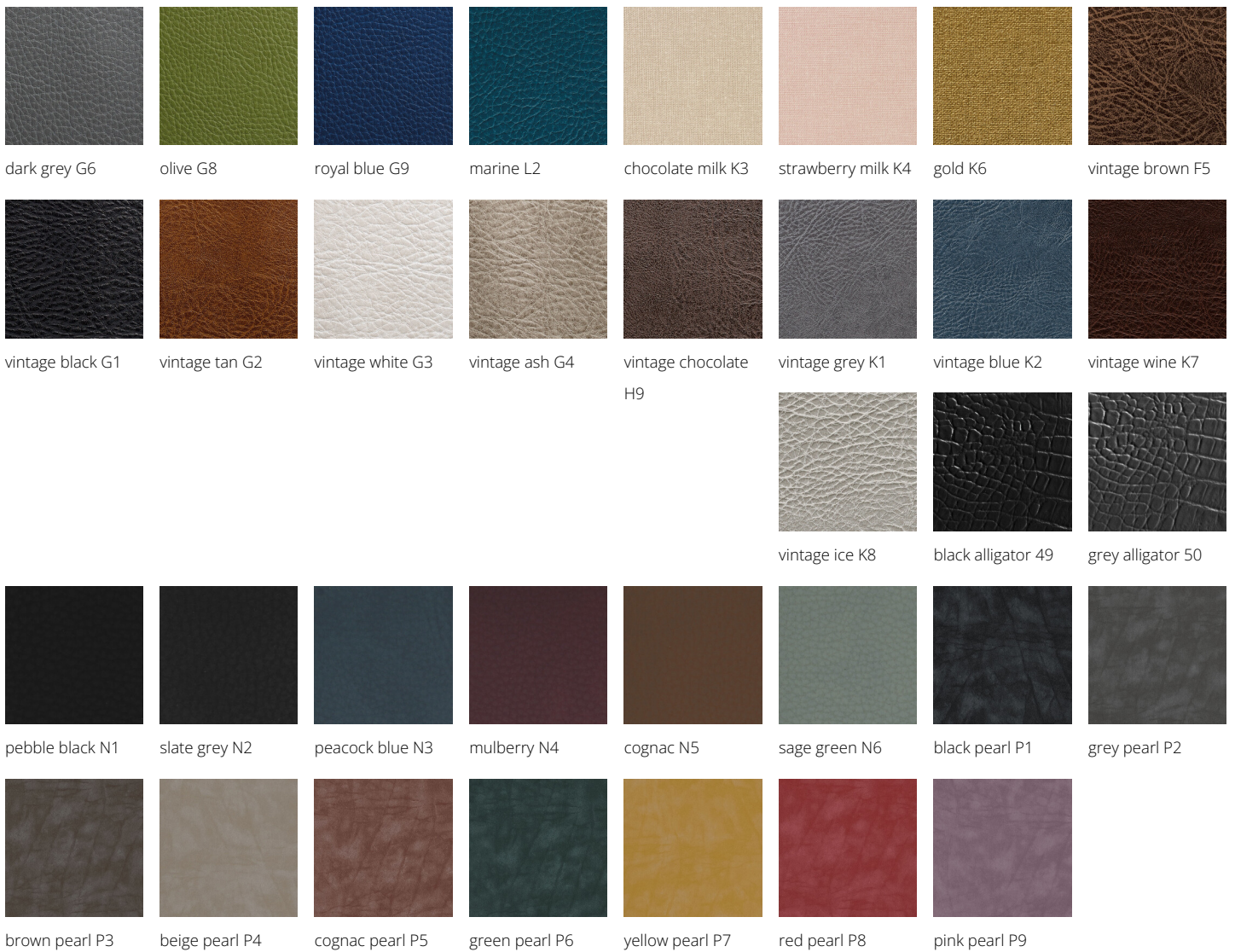

Via Lazzaretti 12 - 42122 - Reggio Emilia - Italy
 Salon Ambience Italia - +39 0522 276740
 International Sales - +39 0522 276755
 Numero verde - 800 144552
 Fax - +39 0522 276767
 E-mail: info@salonambience.com

<https://www.facebook.com/salonambiencegroup>
<https://www.instagram.com/salonambiencegroup/>
https://www.youtube.com/channel/UCqTdWM-4_65Tr0Jul82kSCQ