



Rodeo Manicure: Sgabello per centro estetico

Versatile e compatto, Rodeo Manicure offre una semplice soluzione mobile per piccoli interventi di manicure! Una robusta mensola bianca con ampio spazio di lavoro è collegata a questo sgabello ergonomico, disponibile in una vasta scelta di Skai Colours senza alcun costo aggiuntivo.

ARTICOLI

MB/S134

Le immagini sono fornite al solo scopo illustrativo e non costituiscono elemento contrattuale

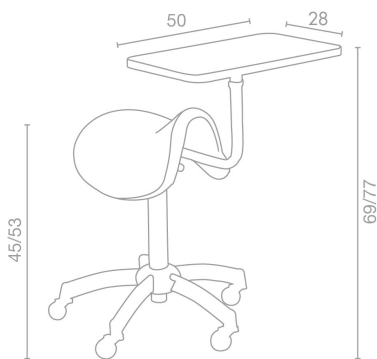

Tutti i prodotti Medical&Beauty sono disponibili in una vasta scelta di colori senza costi aggiuntivi!



champagne 10



black coffee 59



hot chocolate 60



milk 61



tea 62

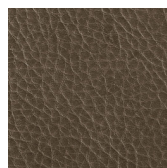

cappuccino 63



espresso 64



light grey G5



dark grey G6

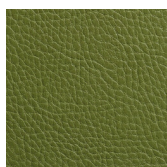

olive G8



royal blue G9

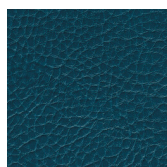

marine L2



chocolate milk K3

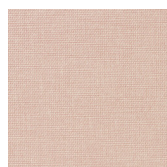

strawberry milk K4

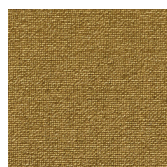

gold K6

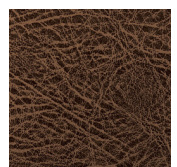

vintage brown F5



vintage black G1



vintage tan G2



vintage white G3



vintage ash G4



vintage chocolate
H9

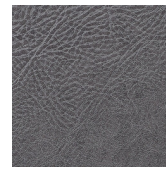

vintage grey K1

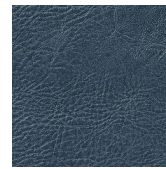

vintage blue K2



vintage wine K7



vintage ice K8

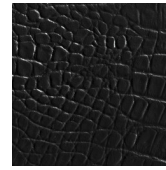

black alligator 49

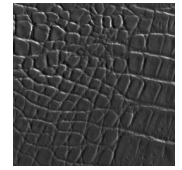

grey alligator 50

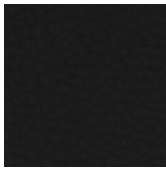

pebble black N1

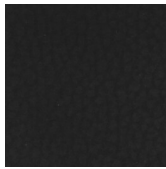

slate grey N2

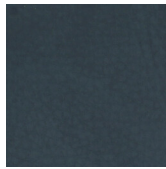

peacock blue N3

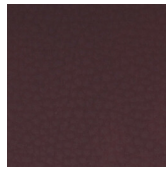

mulberry N4



cognac N5

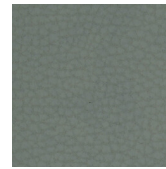

sage green N6

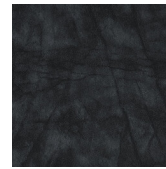

black pearl P1

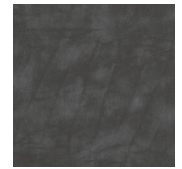

grey pearl P2

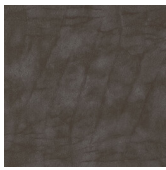

brown pearl P3



beige pearl P4

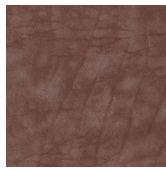

cognac pearl P5



green pearl P6



yellow pearl P7

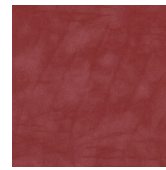

red pearl P8

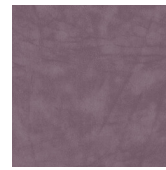

pink pearl P9



Via Lazzaretti 12 - 42122 - Reggio Emilia - Italy

Salon Ambience Italia - +39 0522 276740

International Sales - +39 0522 276755

Numero verde - 800 144552

Fax - +39 0522 276767

E-mail: info@salonambience.com

<https://www.facebook.com/salonambiencegroup>

<https://www.instagram.com/salonambiencegroup/>

https://www.youtube.com/channel/UCqTdWM-4_65Tr0Jul82kSCQ